



N35.150 GRAFTER BLUE

Chassis Cab



specifications:

Isuzu 'Grafter Blue' N35.150 3.5T GVW / EURO VI 4x2 rigid twin rear wheels

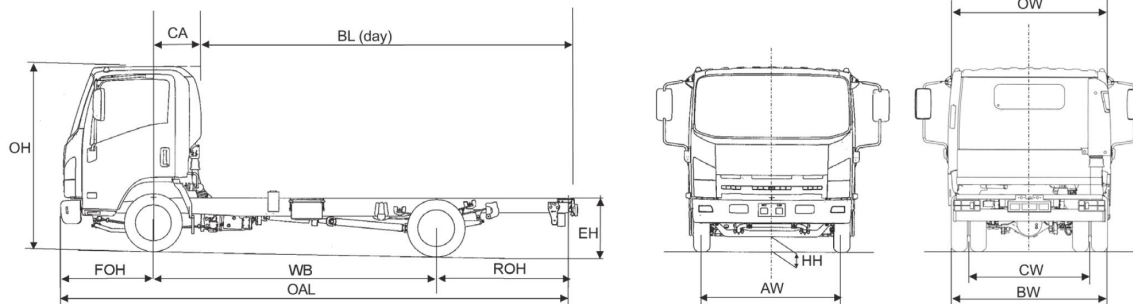

Axle weights (kg)			
UK maximum Vehicle Weights (kg)	GVW	3500	3500
	GTW*	7000	7000
UK Axle design weights (kg)	Front	2100	2100
	Rear	2435	2435

Weights (kg)			
Cab type		day	day
Wheelbase	WB	2750	3350
Vehicle Mass Unladen	Front	1490	1510
	Rear	600	632
Total		2090	2142
GVW		3500	3500
Body & Payload Allowance		1410	1358
Max. Permissible Trailer Weight*		3500	3500

Dimensions (mm)			
Overall Length	OAL	5285	6005
Overhang - Front	FOH	1100	1100
Overhang - Rear	ROH	1435	1555
Cab Gap	CB	130	130
C/L Front Axle to Rear of Cab	CA	463	463
Recommended Body Length	BL	3505	4267
Chassis Frame Width		700	700
Recommended Body Width		1945	1945
Recommended Maximum Body Width		2275**	2275**
Cab Width	OW	1770	1770
Overall Height (Unladen)	OH	2150	2160
Chassis Height (Unladen)	EH	725	725
Minimum Road Clearance	HH	195	195
Track - Front	AW	1475	1475
Track - Rear	CW	1425	1425
Rear Axle Width	BW	1855	1855

*Tachograph regulations may apply
**Wide mirror arms apply at extra cost

1. Unladen weights excludes driver, fuel and AdBlue®. (Tolerance +/- 3%). 2. Body lengths are given as a guide only. Bodybuilders are responsible for ensuring all legal requirements are met. 3. Maximum body lengths are calculated to remain within the overhang ratio of 60% of the wheel base. Cab gaps may vary. 4. Isuzu Truck (UK) Ltd. shall have no liability whatsoever should the information supplied have incorrect data, descriptions or illustrations.

N35.150 Mechanical Specification (standard equipment)



EURO VI

POWER & TORQUE

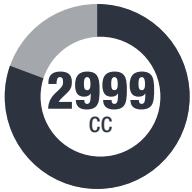
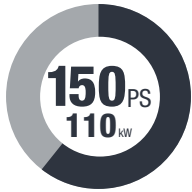
Engine	
Make & model:	4JJ1-TC – Isuzu turbo intercooled DOHC 4 cylinder diesel with DPD & SCR.
Bore x stroke:	95.4 x 104.9mm
Capacity:	Max Power:
	
at 2800rpm	

Transmission	
Make & model:	Isuzu 5 speed manual synchromesh MYY5A with overdrive.
Ratios:	1st - 5.315; 2nd - 2.908; 3rd - 1.558; 4th - 1.000; 5th - 0.721; Reverse - 5.068
Rear Axle Ratio:	3.909:1

Clutch	
Type:	300mm diaphragm type with hydraulic actuation.

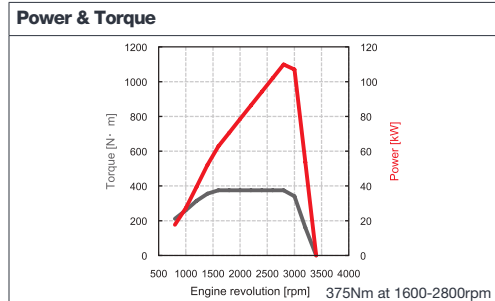

Electrical	
Type:	2x12V, 540CCA, 70Ah batteries (24V) with 50A alternator.



Tyres/Wheels	
Tyres:	205/75 R16 radial.
Wheels:	5.50J x 16, 5-stud.

Frame	
Type:	Parallel ladder type channel section straight side rails, riveted upper flange.

Axles	
Front:	Reverse Elliott I-Beam.
Rear:	Banjo fully floating.

Suspension	
Front:	Semi-elliptical alloy steel springs with hydraulic shock absorbers.
Rear:	Semi-elliptical alloy steel springs with hydraulic shock absorbers.

Brakes	
System:	Vacuum servo assisted hydraulic dual line with ABS, EBD (electronic brake distribution), EVSC (electronic vehicle stability control), ASR (anti slip regulation). Exhaust brake.
Front:	293mm ventilated discs with asbestos free pads.
Rear:	275mm ventilated discs with asbestos free pads.
Park:	Mechanical drum brake rear of transmission.

Fuel Tank Capacity:		
 2750 LITRES	 3350 LITRES	 AdBlue®: 16 LITRES

SAFETY & SECURITY

R29 cab strength:	Complies with ECE-R29 cab strength standard.
Central locking:	Central locking with remote keyless entry and immobiliser.
Rear bumper:	Aluminium rear under run bar.
Seatbelts:	Red diagonal and lap belts.

CAB FEATURES

Cab Exterior	
Type:	Hexapod, white all-steel.
Features:	Manual tilt to 45 deg. Tinted windscreen. Chrome radiator grille. Plastic resin non-slip entry steps. 90 deg. opening doors. Zinc galvanised frame structure, Steel reinforced composite front bumper with fog and daytime running lamps. Two halogen head lamps with indicators. Front mudguards with spray suppression. Keyless door entry and immobiliser.

Cab Interior	
Features:	Flame-resistant interior trim. Vinyl floor matting. Pillar mounted entrance grab handles both sides. Driver & passenger SRS airbags.

Seats (cloth)	
Features:	Driver's fully adjustable suspension seat with head restraint. Dual passenger seat with folding back. Driver and outer passenger retractable diagonal seat belts with pre-tensioner. Centre seat lap belt.

Vision	
Features:	Large foldable mirrors. Interior rear view mirror on collapsible mounting. Driver and passenger sun visors. Deep cut side windows to reduce blind spots. Electric windows with driver control and lock.

Steering	
Features:	Rack and pinion with full integral hydraulic power assistance. Tilt and telescopic steering column.

Instruments	
Features:	Speedometer with odometer & trip. Rev counter. Fuel gauge. Engine coolant temperature. Multi-information display provides information on servicing, emissions and fuel economy.

Switches & Electrical	
Features:	Combination stalk incorporating headlamps, indicators, fog lamps, washers and wipers, and exhaust brake. Steering wheel horn. Engine idle control. Headlamp levelling. Engine quick warm up. Cigarette lighter. Reverse warning. DPD. EVSC, ASR. Hazard warning lights. Kenwood DAB radio with Bluetooth (Sat Nav option available)

Warning/Indicator Lamps	
Features:	Battery charge. Oil pressure. Low fuel. Glow plug operation. High beam and indicators. Park brake warning. Fuel/water separator. Check engine. DPD operation. Engine overheat. AdBlue® level. ABS. Exhaust brake operation. Front and rear fog lights. Seatbelt warning. Brake fluid level. SRS air bag. Brake vacuum loss.

Tool Kit	
Features:	Jack with a small selection of hand tools.

WARRANTY

All chassis cabs come with a 3 year unlimited mileage warranty and roadside assistance as standard. Terms and conditions apply.

Isuzu-backed Repair and Maintenance contracts available upon request.