

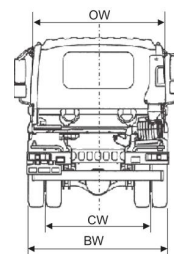

specifications:

Isuzu 'Forward' F110.210(E) 11.00T GVW / EURO VI (Easyshift transmission) 4x2 rigid

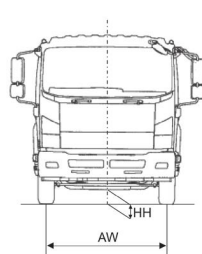
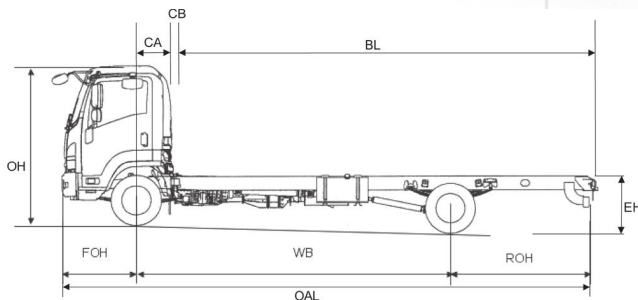

Axle weights (kg)					
UK standard vehicle plated weights (kg)	GVW	11000	11000	11000	11000
	GTW	14500	14500	14500	14500
UK Axle design weights (kg)	Front	4000	4000	4000	4000
	Rear	7600	7600	7600	7600

Weights (kg)					
Cab type		day	day	day	day
Wheelbase	WB	3410	4060	4660	4990
Vehicle Mass Unladen	Front	2208	2266	2310	2378
	Rear	1256	1280	1286	1312
Total		3464	3546	3596	3690
GVW		11000	11000	11000	11000
Body & Payload Allowance		7536	7454	7404	7310
Max. Permissible Trailer Weight		3500	3500	3500	3500

Dimensions (mm)					
Overall Length	OAL	6010	7000	7900	8350
Overhang - Front	FOH	1170	1170	1170	1170
Overhang - Rear	ROH	1430	1770	2070	2190
Cab Gap	CB	150	150	150	150
C/L Front Axle to Rear of Cab	CA	556	556	556	556
Recommended Body Length	BL	4500	5400	6250	6750
Chassis Frame Width		840	840	840	840
Recommended Body Width		2550	2500	2500	2500
Recommended Maximum Body Width		2550	2550	2550	2550
Cab Width	OW	2195	2195	2195	2195
Overall Height (Unladen)	OH	2510	2510	2510	2505
Chassis Height (Unladen)	EH	895	930	930	930
Minimum Road Clearance	HH	185	165	165	165
Track - Front	AW	1795	1795	1795	1795
Track - Rear	CW	1660	1660	1660	1660
Rear Axle Width	BW	2220	2220	2220	2220

1. Unladen weights excludes driver, fuel, AdBlue®, Includes spare wheel + carrier (Tolerance +/- 3%). 2. Body lengths are given as a guide only. Bodybuilders are responsible for ensuring all legal requirements are met. 3. Maximum body lengths are calculated to remain within the overhang ratio of 60% of the wheel base. Cab gaps may vary. 4. Isuzu Truck (UK) Ltd. shall have no liability whatsoever should the information supplied have incorrect data, descriptions or illustrations.

F110.210(E) Mechanical Specification (standard equipment)

EURO VI

POWER & TORQUE

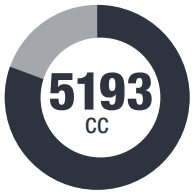
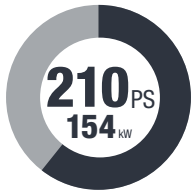
Engine	
Make & model:	4HK1E6S – Isuzu turbo intercooled OHC 4 cylinder diesel with DPD & SCR.
Bore x stroke:	115 x 125mm
Capacity:	Max Power:
	
at 2600rpm	

Transmission	
Make & model:	Isuzu electro hydraulic controlled 6-speed MZW6P with fully automated and sequential shift modes.
Ratios:	1st - 6.615; 2nd - 4.095; 3rd - 2.358; 4th - 1.531 5th - 1.000; 6th - 0.722; Reverse - 6.615
Rear Axle Ratio:	4.555:1 (diff lock on 3410mm only)

Clutch	
Type:	Fluid hydrokinetic coupling with lock-up clutch.

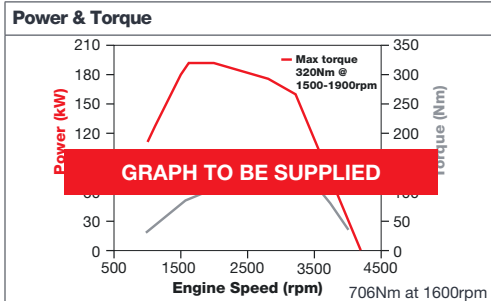

Electrical	
Type:	2x12V, 800CCA, 110Ah batteries (24V) with 90A alternator.



Tyres/Wheels	
Tyres:	235/75 R17.5 radial.
Wheels:	6.75J x 17.5, 6-stud.
Spare:	1 x wheel and tyre.

Frame	
Type:	Parallel ladder type channel section straight side rails, riveted upper flange.

Axles	
Front:	Reverse Elliott I-Beam.
Rear:	Banjo fully floating.

Suspension	
Front:	Multi taper-leaf steel springs with hydraulic shock absorbers and anti roll bar.
Rear:	Multi taper-leaf steel springs with helper.

Brakes	
System:	Air over hydraulic dual circuit with ABS, EBD (electronic brake distribution), EVSC (electronic vehicle stability control), ASR (anti slip regulation). Exhaust brake. Air dryer.
Front:	320mm x 120mm drum with auto adjust.
Rear:	320mm x 145mm drum with auto adjust.
Park:	Rear wheel spring brake.

Fuel Tank	
Capacity:	
AdBlue®:	

CAB FEATURES

Cab Exterior	
Type:	Hexapod, white all-steel with roof outline markers.
Features:	Manual tilt to 45 deg. Tinted windscreen. Chrome radiator grille. Plastic resin non-slip entry steps. 90 deg. opening doors. Zinc galvanised frame structure. Steel reinforced composite front bumper with fog and daytime running lamps. Two halogen head lamps with indicators. Front mudguards with spray suppression. Aluminium rear under run.

Cab Interior	
Features:	Flame-resistant interior trim. Vinyl floor matting. Dual long grab handles each side. Interior fluorescent lighting. Driver & passenger SRS airbags.
Storage space:	Centre seat back compartment, twin overhead lockers, centre tray, door and dashboard pockets.

Seats (all cloth)	
Features:	Driver's fully adjustable Isringhausen® air-suspended seat with head restraint and 3-point seat belt with pretensioner. Rigid centre seat with 2-point seatbelt. Rigid passenger seat with head restraint and 3-point seat belt pretensioner.

Vision	
Features:	Large door mounted heated adjustable mirrors. Front underview mirror and kerb mirror. Driver and passenger sun visors. Deep cut side windows to reduce blind spots. Electric windows with driver control and lock.

Steering	
Features:	Recirculating ball type with full integral hydraulic power assistance. Tilt and telescopic steering column.

Instruments	
Features:	Speedometer with odometer and trip. Rev counter. Multi-information display provides information on servicing, emissions and fuel economy. Fuel gauge. Coolant temperature gauge. Air pressure gauge. Digital Tachograph.

Switches & Electrical	
Features:	Combination stalk incorporating headlamps, indicators, fog lamps, washers and wipers, and exhaust brake. Cruise control. Steering wheel horn. Engine idle control. Headlamp levelling. Engine quick warm up. Cigarette lighter. Reverse warning. DPD, EVSC, ASR and LDWS control. Electronic vehicle speed limiter set at 56 mph (90 kph). First gear start. Economy mode. Hazard warning lights. Kenwood DAB radio with Bluetooth (Sat Nav option available)

Warning/Indicator Lamps	
Features:	Battery charge. Oil pressure. Low fuel. Glow plug operation. High beam and indicators. Park brake warning. Fuel/water separator. Check engine. DPD operation. Engine overheat. AdBlue® level. EVSC, LDWS, ABS. Exhaust brake operation. Front and rear fog lights. Seatbelt warning. Brake fluid level. SRS air bag. Low air warning. Gear position indicator. Cab tilt warning.

Tool Kit	
Features:	Jack with a small selection of hand tools.

WARRANTY

All chassis cabs come with a 3 year unlimited mileage warranty and roadside assistance as standard. Terms and conditions apply.

Isuzu-backed Repair and Maintenance contracts available upon request.

SAFETY & SECURITY

R29 cab strength:	Complies with ECE-R29 cab strength standard.
Central locking:	Central locking with remote keyless entry and immobiliser.
Lane departure warning system:	Camera monitor, alerts driver with a warning buzzer and LCD monitor.
Red Seatbelts:	3-point Securon seat belt (without inertia-locking retractor).